

Viticulture & Winery Solutions

ENGINEERED INNOVATION

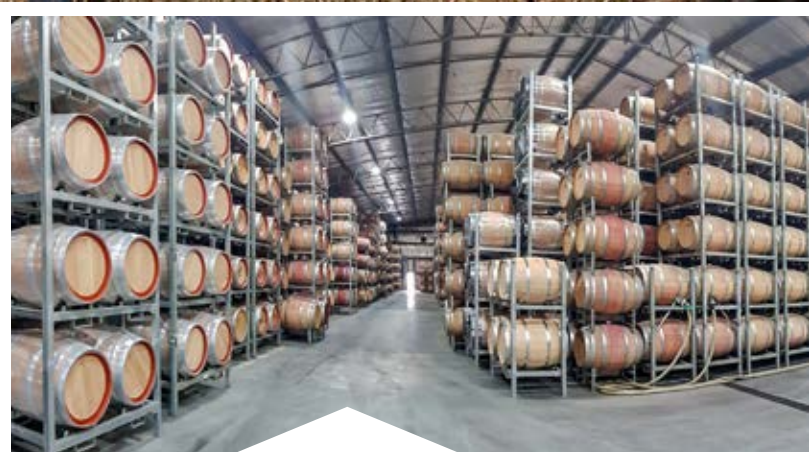



“Big enough
to deliver, small
enough to care.”

Spanlift Team

Trusted by the Best





Barrel Store 4

Barrel Store

Cellar Door 6

Cellar Door

Machinery Sheds & Workshops 8

Machinery Sheds & Workshops

Barrel Master 10

Barrel Master

Barrel Racks 12

Barrel Racks

Grape Bins 14

Grape Bins

Produce Bins 16

Produce Bins

Barrel Store



State of the art Barrel Stores

Spanlift understands that when it comes to storing wine, you want a constant temperature all year round. We can provide you with more than just a shed when it comes to your barrel store.

We can help you with:

- Insulated wall and ceiling systems up to R5
- Double skin cladding
- Column placements suited to barrel storage patterns and barrel washing equipment
- Maximising your barrel storage height
- Door configurations and layouts to suit your operation
- External loading canopies
- Easy to clean wall and ceiling lining systems
- A visual design that reflects your individual style
- Design smarts which allow building functionality in the future



With the right building, you'll get more from your investment for many years to come.

You make the best wine and we make the best buildings, as a team we can produce an industry leading facility to progress your winery to the next level.

Cellar Door



Cellar doors designed into your Barrel Store / Winery

The cellar door is the face of your brand to the public. The Spanlift engineering team will work with you to achieve the desired building design. To have a design which will make a positive visual impact for years to come, while also providing functionality and efficiency in the workplace.

The structural steel is fully hot dip galvanized to ensure longevity of the building with low long term maintenance requirements.

- Mezzanines
- Office fronts
- Building style to complement winery
- Canopy's





Cellar Door

With the right building, you'll get more from your investment for many years to come.

Spanlift has a library of pre-engineered building designs. With a specialized design team, pre-processed componentry, customized are made easy!



Discuss your future with us today.

Machinery Sheds & Workshops



Protect your equipment from the elements

Your workshop becomes the hub of your vineyard. When your next workshop may well be round for the next 4 generations, getting the design right is important.

For your next workshop speak to Spanlift about:

- Drive through maintenance bays
- Door opening configurations to suit your operation
- Skillion covers over doorways or other external areas
- Wash down bays for machinery
- Mezzanine floors for storage lockup or office accommodation
- Natural lighting where you need it most
- Internal & external lighting
- Bird & vermin resistant design
- Service pits for regular maintenance
- Unique gutter systems, where deluge overflow runs to the outside only
- Obtaining required council approvals & permits



Machinery
Sheds &
Workshops

Spanlift has you covered!

From our site inspection and proposal process to Council Approval assistance through to fast onsite installation we can help make your ideal workshop a reality.



Discuss your future with us today.

Barrel Master



Self Supporting Barrel Racking System

- Steel on steel racking – safer, no weight on barrels, minimises potential leakage
- Unique patented locating system without protrusions provides ultimate ease when forklifting
- Super strong construction using larger diameter steel tubing
- Seismically rated as superior to all other racks and designs
- No floor space loss and closer stacking as rack frame is within the barrel perimeter
- Higher stacking ability to maximize cellar storage, plus more space for topping/sampling
- Simple design gives a beautiful uncluttered look in the barrel cellar
- Will last a lifetime – choose from Pre-Galvanized or Hot Dip Galvanized
- Safer stacking of different sized barrels from all cooperages
- Barrels cannot roll off the rack accidentally
- Four-sided access with forklift or hand operated pallet truck
- Optional rollers for manual and semi-automatic barrel rotation
- Custom made to order

Unique patented interlocking system

- No protruding feet to catch on staff or machinery
- Saves warehouse space
- Excellent visibility for checking proper engagement
- Positive locating points
- No special skills required for stacking

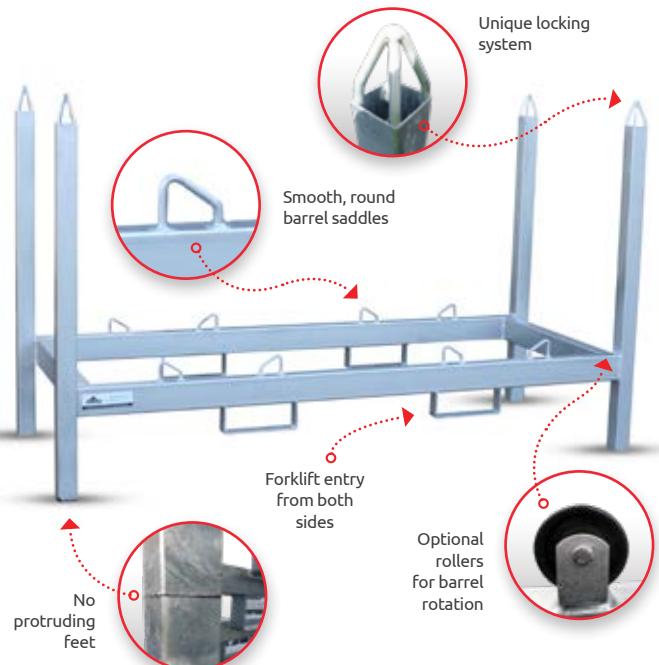

Additional Options

- Rollers for Manual Barrel Rotation
- Tyne Guide Channels
- Powder Coat in any colour (display only)

Greater Safety



Competitor
Locating feet that protrude can cause dangerous catch of adjacent stacks



Barrel Master
Our unique locating system has no protrusions. Save precious warehouse space too!

Space Saving & Height Safety

- Rack frame is within the barrel perimeter
- No reliance on barrel integrity or strength
- Better footprint on floor for greater stack stability
- Can stack up to 8 high safely
- Up to 65% better use of floor space compared to traditional stacking methods
- Gives more space between barrels top and bottom for topping, sampling and pumping

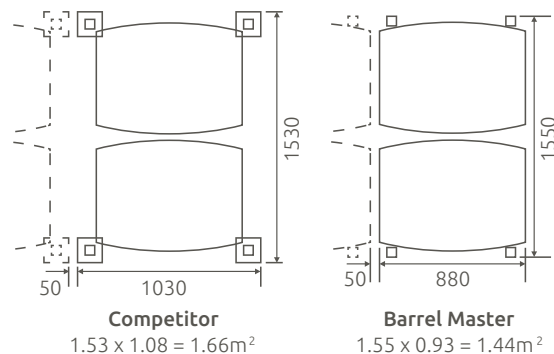

Barrel Master

Specifications

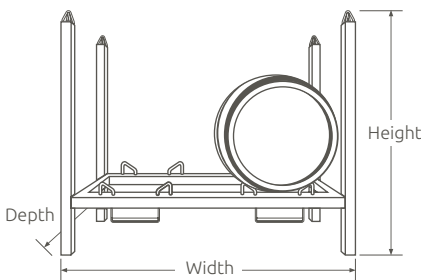

Economical Freight Methods

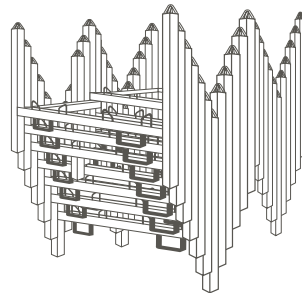

- Racks stack into tight bundles for best freight rates
- Saves winery floor space when not in use and upon delivery

Type	Barrel Size	Barrels p/rack	Width (mm)	Depth (mm)	Height (mm)	Stack Qty
Barrique	225/228L	2	1550	810	900	11/22
Barrique - Single Puncheon	500L	1	1550	810	1100	11/22
Universal	225/228/300L*	2	1610	810	950	11/22
Universal - Single Puncheon	500L	1	1610	810	1100	11/22
Universal - Single Demi Muid	600L	1	1610	810	1250	11/22
Combo	225/228/300L	2	1740	810	950	11/22
Combo - Single Puncheon	500L	1	1740	810	1100	11/22
Combo - Single Demi Muid	600L	1	1740	810	1250	11/22
Puncheon	500L	2	1980	950	1100	13
Demi Muid [^]	600L	2	2230	880	1250	12

*Small 300L Hogshead only - larger type needs to use Combo footprint

[^] Racks for barrels larger than Demi Muid can be made to order on request

Barrel Racks



Built tough, with the end user in mind

Imagine a wholly welded wine barrel rack that is ready to use immediately upon delivery. Gorilla Products' wine barrel rack requires no time consuming bolt assembly so they are quick, easy and safe. Stack up to five racks high with the barrel rack design.

The difference is in the design, they are light yet robust, able to be stacked on the floor or barrels and the round saddles allow for barrel positioning without 'digging in'.

- Angle iron construction for strong, clean, maintenance free utility
- Revolutionary space-saving with stacking capacity up to four high
- Light yet robust centre for superior stacking stability and unyielding steadfastness through forklift side-entry
- Minimal freight costs as a result of close stacking
- Hot Dip Galvanized after manufacture to ensure best possible coating for long service life
- Models available to suit Barriques, Hogsheads and Puncheons

Specifications

Eight standard sizes with two barrels per rack.
 These dimensions are for standard racks - does not apply for custom made racks.

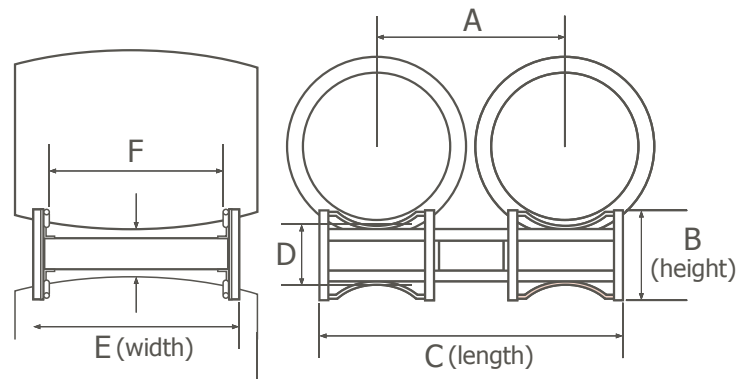

Type	Barrel Size	A (mm)	B (height mm)	C (length mm)	D (mm)	E (width mm)	F (mm)
Mini (Bourbon)	100L/110L	610	360	1070	232	520	440
Standard Barrique	225L/228L	810	360	1300	232	770	675
High Barrique	225L/228L	810	380	1300	262	770	675
Standard Hogshead	300L only	810	360	1300	232	870	775
High Hogshead	300L only	810	380	1300	262	870	775
Standard Universal	225L/228L/300L	810	360	1300	232	825	730
High Universal	225L/228L/300L	810	380	1300	262	825	730
Standard Puncheon	500L only	950	390	1490	260	945	850



Barrel Racks

Registered Design

The design of this wine barrel rack is protected from any identical or similar manufacture either for sale or own use under Registered Design No. 117931.

Grape Bins



A tough harvest time workhorse

Gorilla Grape Bins are tough, portable and big. With 2.85 cubic metres of bin you will have plenty of storage on hand. Every Gorilla Grape Bin has a polyethylene liner of 100% food-grade quality. So you can store grapes in conditions that meet Australia's strictest standards for food storage. That means you can rest easy that your grape stocks will be kept hygienic and corrosion-free.

Gorilla Grape Bins are so industry-centric that they deliver on all key commercial drivers. Designed specifically for agriculture and viticulture purposes, our grape bins previously bore the acclaimed Falland name.

- Fully UV stabilised to last against the sun's rays and harsh elements
- 100% food-grade quality polyethylene
- Fitted in to steel frame with stainless steel bolts and lock nuts
- Strong steel frame that is tough enough to handle rough treatment
- Hot dip galvanized that ensures long life
- Many options available for stacking, locating, lifting, etc.
- Choice of liner colours for individual identification
- An option for your logo, branding and tracking available
- 2850lt capacity
- Optional bin lid

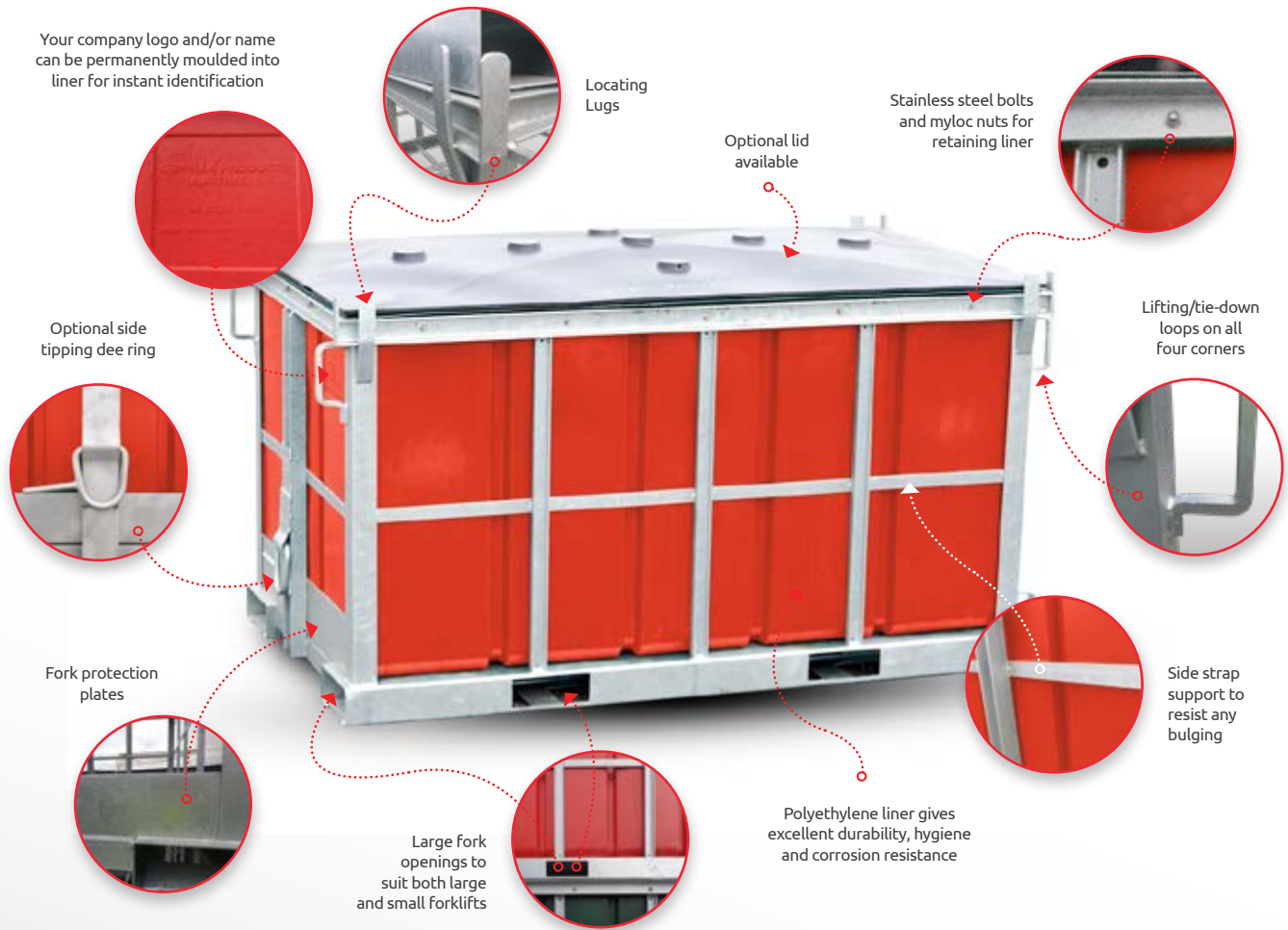

Colours available

Gorilla Grape Bins offer a choice of smart colours for individual identification. You can even emboss your company logo into the bin liner, if you want.

Standard Colours



Gorilla Red



Heritage Green
(Cottage Green™)



Wheat (Harvest®)

Made to Order*



Play Purple



Orange Spray



Standard Yellow



Trans Blue



White (Surf Mist™)



Black Night (Night Sky)



Mist Green (Pale Eucalyptus®)

*All made to order items are approximately 4 week lead time from order. Must be ordered in multiples of 2.

Grape Bins

Produce Bins



Colours Available

Gorilla Produce Bins offer a choice of smart colours for individual identification.

You can even emboss your company logo into the bin liner, if you want.

Standard Colours

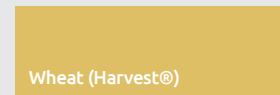
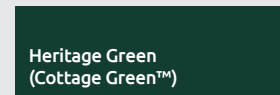

Made to Order*

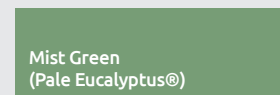
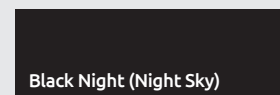
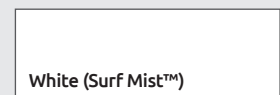
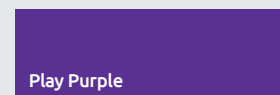

We make them tough... they will outlast PVC bins by several times

Produce requires premium bin technology. So that is exactly what Gorilla Produce Bins deliver. Each Produce Bin has the same big, tough, innovative features as Gorilla Grape Bins.

The bin is housed into a fully hot dip galvanized pallet size steel frame, which is designed for use by forklift from two sides for rotation, and a pallet truck from the opposite two sides for casual movement. It has strong fork protection plates to prevent bin damage and is designed to multiple stack.

- Full UV stability to withstand Australia's harshest elements
- Forklift maneuverability for easy rotation
- Compatibility with casual pallet truck portability on non-rotating sides
- Multiple stacking design for serious space saving
- Choose from a range of colours for storage identification
- Sizes available: 850lt, 1000lt, 1450lt
- Lids available to suit every bin

*All made to order items are approximately 4 week lead time from order. Must be ordered in multiples of 2.

Grape Bin Trailers

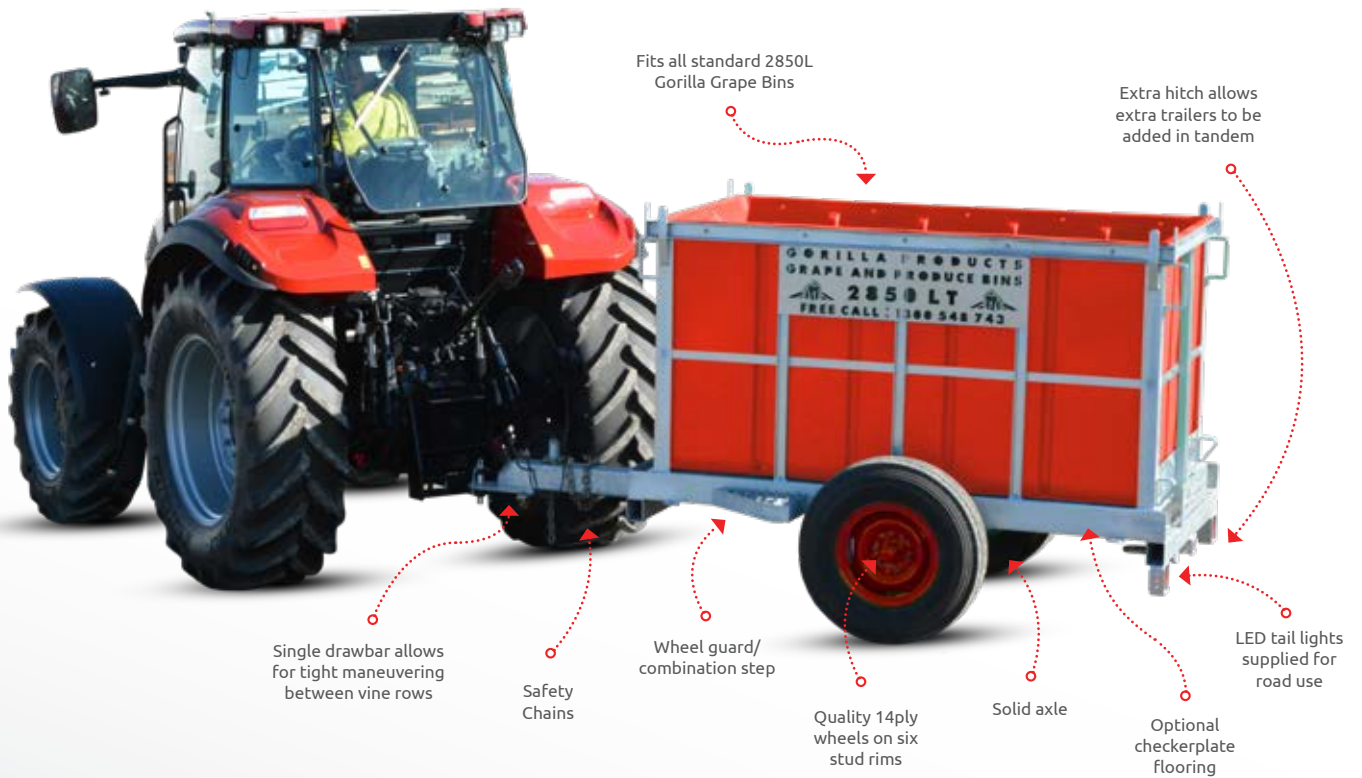

Specifically designed to carry our grape bin with ease and practicality. The Gorilla trailer is made tough to withstand the rigors of harvest time and can also be used as a post trailer and also a tool trailer.



Produce Bins

In the making...

Since 1954, we've been fabricating steel solutions



Understanding the needs of our clients



Complete solution



Delivered in full



Turning plans into reality



Manufactured to perfection



Managed by the team



Galvanized for the future



Engineered Innovation





Call us today, we'd love to have a chat with you from the comfort of your own winery / vineyard to discuss your new project.

Spanlift Australia has you covered! From our range of buildings to viticulture products, we are sure we can help you.

With your new shed, your journey begins with a site inspection and custom proposal. This is followed by careful design and planning with our in-house team. We do the hard work for you in supplying all the necessary building approval documentation, and help you obtain the relevant permits before beginning construction of your shed.

When it comes to your winery & vineyard needs, we keep our Gorilla Products stock in a few different locations around Australia in order to get it to you faster. With every rack and bin manufactured under the stringent quality control of Spanlift Australia, you know you're only getting what you deserve – the very best.

844 South Rd, Edwardstown SA 5039
12C Wireless Rd East, Mount Gambier SA 5290
Call **1300 234 321** or visit **www.spanlift.com.au**

